



Features

- Constant Voltage + Constant Current mode output
- Metal housing with class I design
- Standby power consumption <0.5W at remote off
- IP67 / IP65 rating for indoor or outdoor installations
- Function options: output adjustable via potentiometer; 3 in 1 dimming (dim-to-off)
- Typical lifetime > 62000 hours
- 7 years warranty

Applications

- LED high-bay lighting
- Parking space lighting
- LED fishing lamp
- LED greenhouse lighting
- Type “HL” for use in Class I , Division 2 hazardous (Classified) location.

Description

HLG-600H series is a 600W AC/DC LED driver featuring the dual mode constant voltage and constant current output. HLG-600H operates from 90 ~ 305VAC and offers models with different rated voltage ranging between 12V and 54V. Thanks to the high efficiency up to 96%, with the fanless design, the entire series is able to operate for -40°C ~ +90°C case temperature under free air convection. The design of metal housing and IP67/IP65 ingress protection level allows this series to fit both indoor and outdoor applications. HLG-600H is equipped with various function options, such as dimming methodologies, so as to provide the optimal design flexibility for LED lighting system.

Model Encoding

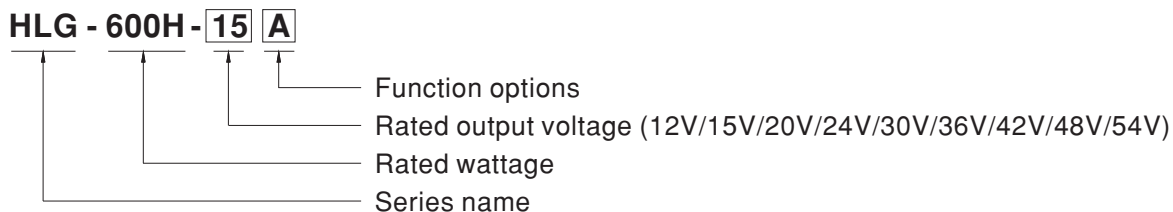

| Type | IP Level | Function | Note |
|-------|----------|--|----------|
| A | IP65 | Io and Vo adjustable through built-in potentiometer | In Stock |
| B | IP67 | 3 in 1 dimming function (0~10VDC, 10V PWM signal and resistance) | In Stock |
| AB | IP65 | Io and Vo adjustable through built-in potentiometer & 3 in 1 dimming function (0~10VDC, 10V PWM signal and resistance) | In Stock |
| Blank | IP67 | Io and Vo fixed | In Stock |

SPECIFICATION

| MODEL | | HLG-600H-12 | HLG-600H-15 | HLG-600H-20 | HLG-600H-24 | HLG-600H-30 | HLG-600H-36 | HLG-600H-42 | HLG-600H-48 | HLG-600H-54 | |
|--|---|--|--------------|-------------|--------------|--------------|--------------|--------------|--------------|--------------|--------|
| OUTPUT | DC VOLTAGE | 12V | 15V | 20V | 24V | 30V | 36V | 42V | 48V | 54V | |
| | CONSTANT CURRENT REGION <small>Note.4</small> | 6 ~ 12V | 7.5 ~ 15V | 10 ~ 20V | 12 ~ 24V | 15 ~ 30V | 18 ~ 36V | 21 ~ 42V | 24 ~ 48V | 27 ~ 54V | |
| | RATED CURRENT | 40A | 36A | 28A | 25A | 20A | 16.7A | 14.3A | 12.5A | 11.2A | |
| | RATED POWER | 480W | 540W | 560W | 600W | 600W | 601.2W | 600.6W | 600W | 604.8W | |
| | RIPPLE & NOISE (max.) <small>Note.2</small> | 150mVp-p | 150mVp-p | 150mVp-p | 150mVp-p | 200mVp-p | 250mVp-p | 250mVp-p | 250mVp-p | 350mVp-p | |
| | VOLTAGE ADJ. RANGE | Adjustable for A-Type only (via built-in potentiometer) | | | | | | | | | |
| | | 10.2 ~ 12.6V | 12.7 ~ 15.8V | 17 ~ 21V | 20.4 ~ 25.2V | 25.5 ~ 31.5V | 30.6 ~ 37.8V | 35.7 ~ 44.1V | 40.8 ~ 50.4V | 45.9 ~ 56.7V | |
| | CURRENT ADJ. RANGE | Adjustable for A-Type only (via built-in potentiometer) | | | | | | | | | |
| | | 20 ~ 40A | 18 ~ 36A | 14 ~ 28A | 12.5 ~ 25A | 10 ~ 20A | 8.3 ~ 16.7A | 7.1 ~ 14.3A | 6.2 ~ 12.5A | 5.6 ~ 11.2A | |
| | VOLTAGE TOLERANCE <small>Note.3</small> | ± 3.0% | ± 2.0% | ± 1.5% | ± 1.0% | ± 1.0% | ± 1.0% | ± 1.0% | ± 1.0% | ± 1.0% | ± 1.0% |
| LINE REGULATION | ± 0.5% | ± 0.5% | ± 0.5% | ± 0.5% | ± 0.5% | ± 0.5% | ± 0.5% | ± 0.5% | ± 0.5% | ± 0.5% | |
| LOAD REGULATION | ± 2.0% | ± 1.5% | ± 1.0% | ± 0.5% | ± 0.5% | ± 0.5% | ± 0.5% | ± 0.5% | ± 0.5% | ± 0.5% | |
| SETUP, RISE TIME <small>Note.6</small> | 500ms, 80ms / 115VAC, 230VAC | | | | | | | | | | |
| HOLD UP TIME (Typ.) | 15ms / 115VAC, 230VAC | | | | | | | | | | |
| INPUT | VOLTAGE RANGE <small>Note.5</small> | 90 ~ 305VAC 127 ~ 431VDC (Please refer to "STATIC CHARACTERISTIC" section) | | | | | | | | | |
| | FREQUENCY RANGE | 47 ~ 63Hz | | | | | | | | | |
| | POWER FACTOR (Typ.) | PF ≥ 0.98/115VAC, PF ≥ 0.95/230VAC, PF ≥ 0.93/277VAC @ full load (Please refer to "POWER FACTOR (PF) CHARACTERISTIC" section) | | | | | | | | | |
| | TOTAL HARMONIC DISTORTION | THD < 20% (@ load ≥ 50% / 115VAC, 230VAC; @ load ≥ 75% / 277VAC) (Please refer to "TOTAL HARMONIC DISTORTION (THD)" section) | | | | | | | | | |
| | EFFICIENCY (Typ.) | 230VAC | 92% | 93.5% | 94.5% | 95% | 95% | 95.5% | 96% | 96% | 96% |
| | | 277VAC | 92.5% | 93.5% | 94.5% | 95% | 95% | 95.5% | 96% | 96% | 96% |
| | AC CURRENT (Typ.) | 7A / 115VAC 3.3A / 230VAC 2.9A / 277VAC | | | | | | | | | |
| | INRUSH CURRENT(Typ.) | COLD START 70A(twidth=1000μs measured at 50% Ipeak) at 230VAC; Per NEMA 410 | | | | | | | | | |
| | MAX. No. of PSUs on 16A CIRCUIT BREAKER | 1 unit (circuit breaker of type B) / 2 units (circuit breaker of type C) at 230VAC | | | | | | | | | |
| LEAKAGE CURRENT | <0.75mA / 277VAC | | | | | | | | | | |
| STANDBY POWER CONSUMPTION | <0.5W at remote off | | | | | | | | | | |
| PROTECTION | OVER CURRENT <small>Note.4</small> | 95 ~ 108% Constant current limiting, recovers automatically after fault condition is removed | | | | | | | | | |
| | SHORT CIRCUIT | Constant current limiting, recovers automatically after fault condition is removed | | | | | | | | | |
| | OVER VOLTAGE | 13 ~ 16V | 16.5 ~ 20.5V | 22 ~ 26V | 26 ~ 30V | 32.5 ~ 36.5V | 39.5 ~ 43.5V | 46 ~ 50V | 52.5 ~ 56.5V | 59 ~ 63V | |
| | OVER TEMPERATURE | Shut down o/p voltage, re-power on to recover | | | | | | | | | |
| FUNCTION | REMOTE ON/OFF CONTROL | Power on : "High" >2 ~ 5V or Open circuit Power off : "Low" <0 ~ 0.5V or Short circuit | | | | | | | | | |
| | 5V STANDBY | 5Vsb : 5V@0.5A; tolerance ±5%, ripple : 100mVp-p(max.) | | | | | | | | | |
| ENVIRONMENT | WORKING TEMP. | Tcase= -40 ~ +90°C (Please refer to "OUTPUT LOAD vs TEMPERATURE" section) | | | | | | | | | |
| | MAX. CASE TEMP. | Tcase= +90°C | | | | | | | | | |
| | WORKING HUMIDITY | 20 ~ 95% RH non-condensing | | | | | | | | | |
| | STORAGE TEMP., HUMIDITY | -40 ~ +85°C, 10 ~ 95% RH non-condensing | | | | | | | | | |
| | TEMP. COEFFICIENT | ±0.03%/°C (0 ~ 55°C) | | | | | | | | | |
| | VIBRATION | 10 ~ 500Hz, 5G 12min./1cycle, period for 72min. each along X, Y, Z axes | | | | | | | | | |
| SAFETY & EMC (Note 10) | SAFETY STANDARDS <small>Note.7</small> | UL60950-1, UL8750(type"HL"), CSA C22.2 No. 250.13-12, ENEC BS EN/EN61347-1, BS EN/EN61347-2-13 independent, BS EN/EN62384, IP65 or IP67, J61347-1, J61347-2-13, CCC GB4943.1, EAC TP TC 004, AS/NZS 60950.1(by CB)(AB type except), KC61347-1, KC61347-2-13(for 24A,36A,48A,54A only) approved | | | | | | | | | |
| | WITHSTAND VOLTAGE | I/P-O/P:3.75KVAC I/P-FG:2KVAC O/P-FG:1.5KVAC | | | | | | | | | |
| | ISOLATION RESISTANCE | I/P-O/P, I/P-FG, O/P-FG:100M Ohms / 500VDC / 25°C / 70% RH | | | | | | | | | |
| | EMC EMISSION <small>Note.7</small> | Compliance to BS EN/EN55015, BS EN/EN61000-3-2 Class C (@ load ≥ 50%) ; BS EN/EN61000-3-3, EAC TP TC 020; KC KN15, KN61547(for 24A,36A,48A,54A only) | | | | | | | | | |
| | EMC IMMUNITY | Compliance to BS EN/EN61000-4-2,3,4,5,6,8,11, BS EN/EN61547, BS EN/EN55024, light industry level (surge immunity Line-Earth 4KV, Line-Line 2KV), EAC TP TC 020; KC KN15, KN61547(for 24A,36A,48A,54A only) | | | | | | | | | |
| OTHERS | MTBF | 76.9K hrs min. MIL-HDBK-217F (25°C) | | | | | | | | | |
| | DIMENSION | 280*144*48.5mm (L*W*H) | | | | | | | | | |
| | PACKING | 3.9Kg; 4pcs/16.6Kg/0.9CUFT | | | | | | | | | |
| NOTE | <ol style="list-style-type: none"> All parameters NOT specially mentioned are measured at 230VAC input, rated current and 25°C of ambient temperature. Ripple & noise are measured at 20MHz of bandwidth by using a 12" twisted pair-wire terminated with a 0.1uf & 47uf parallel capacitor. Tolerance : includes set up tolerance, line regulation and load regulation. Please refer to "DRIVING METHODS OF LED MODULE". De-rating may be needed under low input voltages. Please refer to "STATIC CHARACTERISTIC" sections for details. Length of set up time is measured at first cold start. Turning ON/OFF the driver may lead to increase of the set up time. The model certified for CCC(GB19510.14, GB19510.1, GB17743 and GB17625.1) is an optional model . Please contact MEAN WELL for details. This series meets the typical life expectancy of >62,000 hours of operation when Tcase, particularly (Tc) point (or TMP, per DLC), is about 75°C or less. Please refer to the warranty statement on MEAN WELL's website at http://www.meanwell.com The driver is considered a component which will be installed into a final equipment. All the EMC tests are been executed by mounting the unit on a 360mm*360mm metal plate with 1mm of thickness. The final equipment must be re-confirmed that it still meets EMC directives. For guidance on how to perform these EMC tests, please refer to "EMI testing of component power supplies." (as available on http://www.meanwell.com) The ambient temperature derating of 3.5°C/1000m with fanless models and of 5°C/1000m with fan models for operating altitude higher than 2000m(6500ft). For any application note and IP water proof function installation caution, please refer our user manual before using. https://www.meanwell.com/Upload/PDF/LED_EN.pdf <p>※ Product Liability Disclaimer : For detailed information, please refer to https://www.meanwell.com/serviceDisclaimer.aspx</p> | | | | | | | | | | |

■ BLOCK DIAGRAM

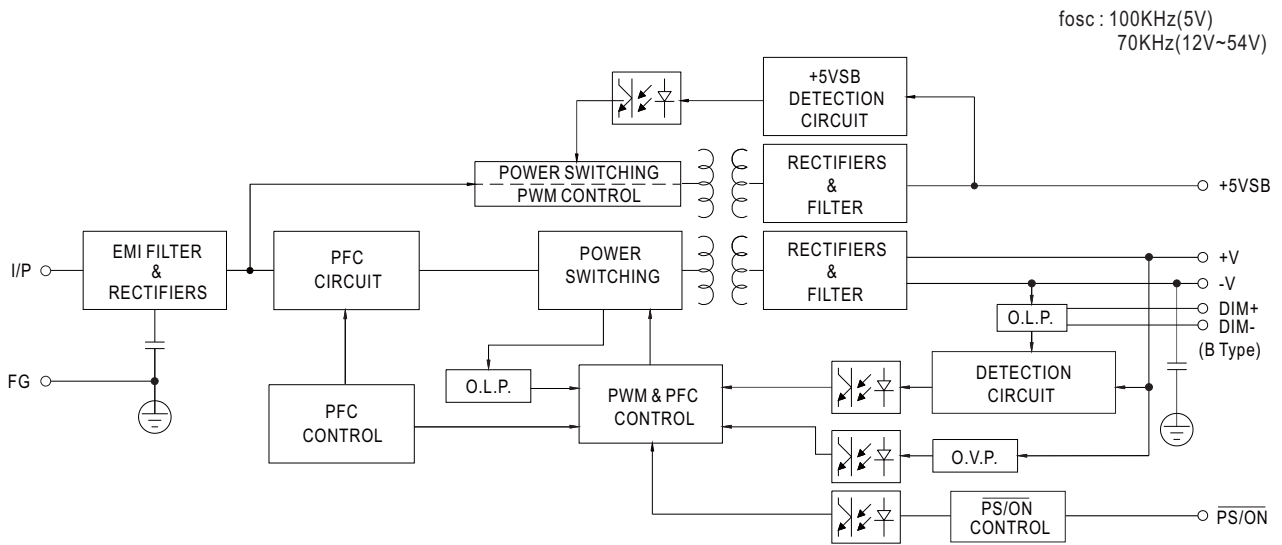

■ DRIVING METHODS OF LED MODULE

※ This series is able to work in either Constant Current mode (a direct drive way) or Constant Voltage mode (usually through additional DC/DC driver) to drive the LEDs.

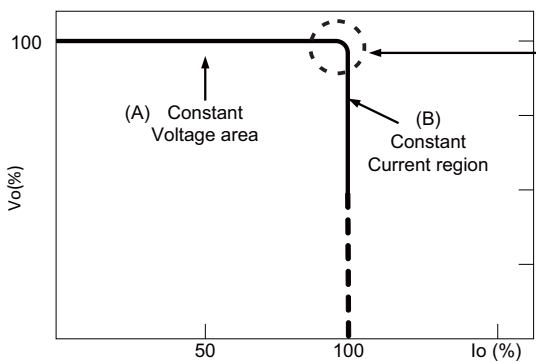

Typical output current normalized by rated current (%)

In the constant current region, the highest voltage at the output of the driver depends on the configuration of the end systems.

Should there be any compatibility issues, please contact MEAN WELL.

DIMMING OPERATION

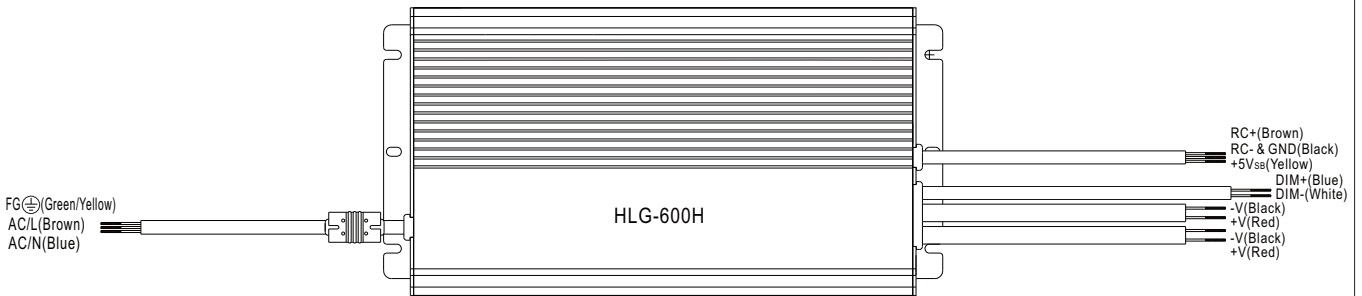

※ 3 in 1 dimming function (for B-Type)

- Output constant current level can be adjusted by applying one of the three methodologies between DIM+ and DIM-: 0 ~ 10VDC, or 10V PWM signal or resistance.
- Direct connecting to LEDs is suggested. It is not suitable to be used with additional drivers.
- Dimming source current from power supply: 100 μ A (typ.)

◎ Applying additive 0 ~ 10VDC

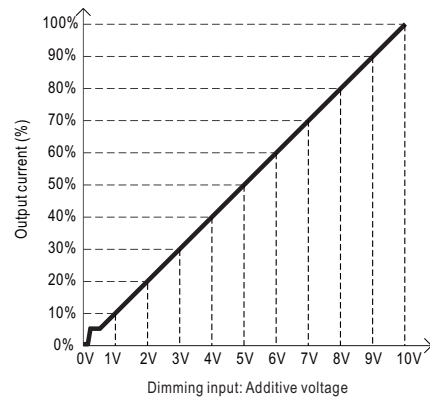
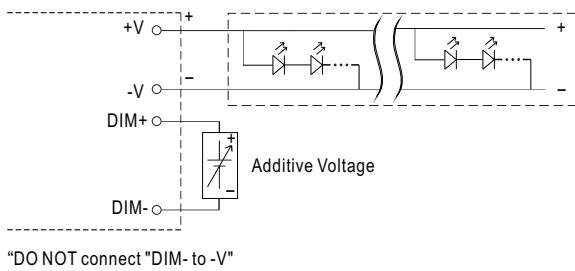

◎ Applying additive 10V PWM signal (frequency range 100Hz ~ 3KHz):

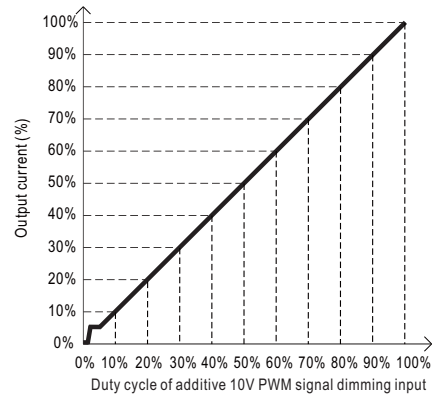
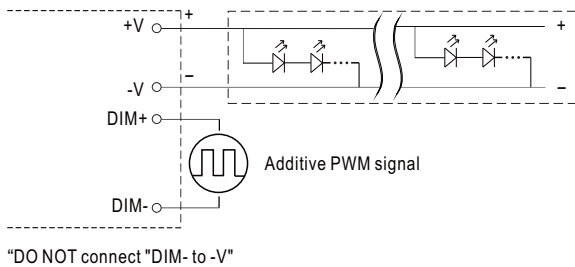

◎ Applying additive resistance:

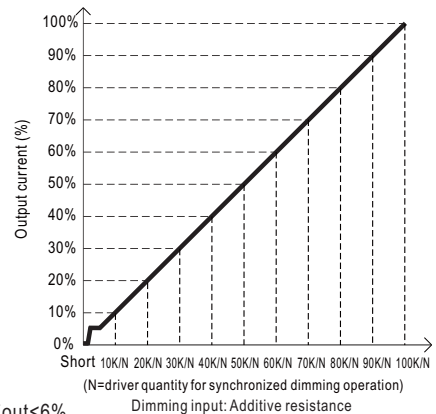
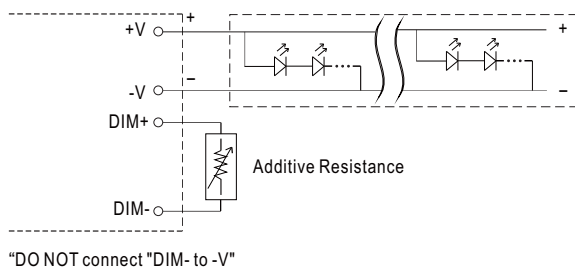

- Note : 1. Min. dimming level is about 6% and the output current is not defined when $0\% < I_{out} < 6\%$.
 2. The output current could drop down to 0% when dimming input is about 0k Ω or 0Vdc, or 10V PWM signal with 0% duty cycle.

OUTPUT LOAD vs TEMPERATURE

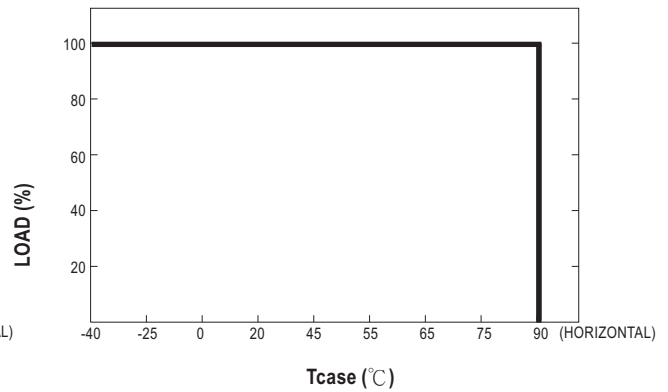
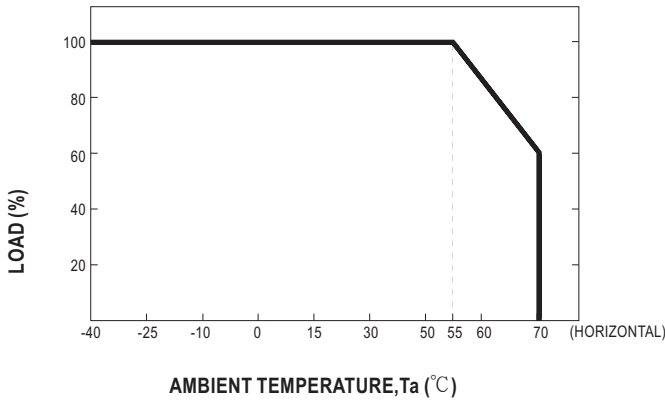

© If HLG-600H operates in constant current mode with the rated current, the maximum workable Ta is 55°C.

STATIC CHARACTERISTICS

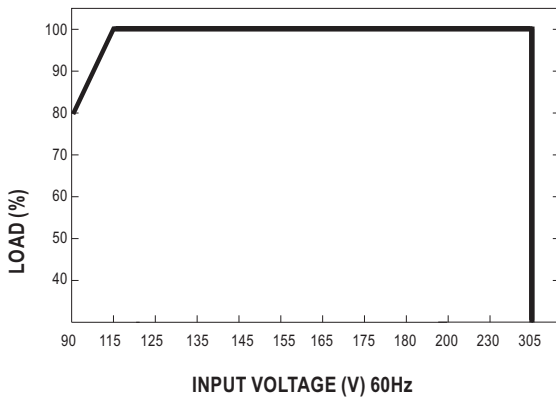

※ De-rating is needed under low input voltage.

POWER FACTOR(PF) CHARACTERISTIC

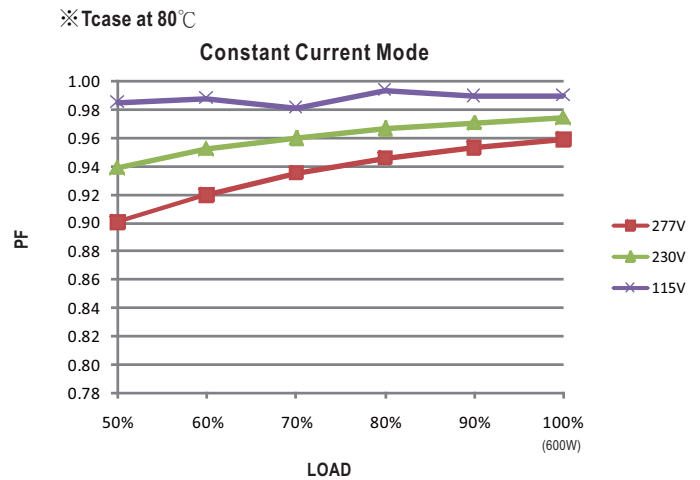

TOTAL HARMONIC DISTORTION (THD)

※ 48V Model, Tcase at 80°C

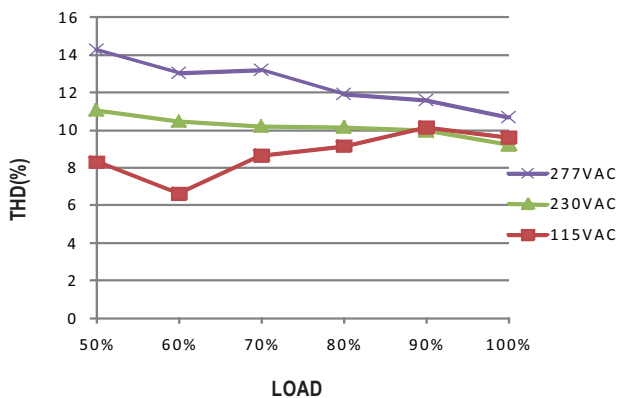

EFFICIENCY vs LOAD

HLG-600H series possess superior working efficiency that up to 96% can be reached in field applications.

※ 48V Model, Tcase at 80°C

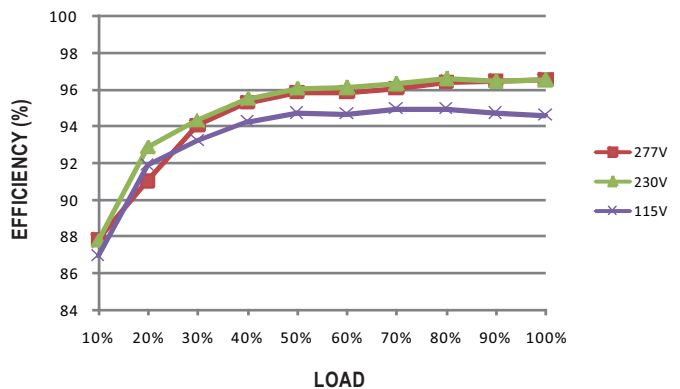



■ LIFETIME

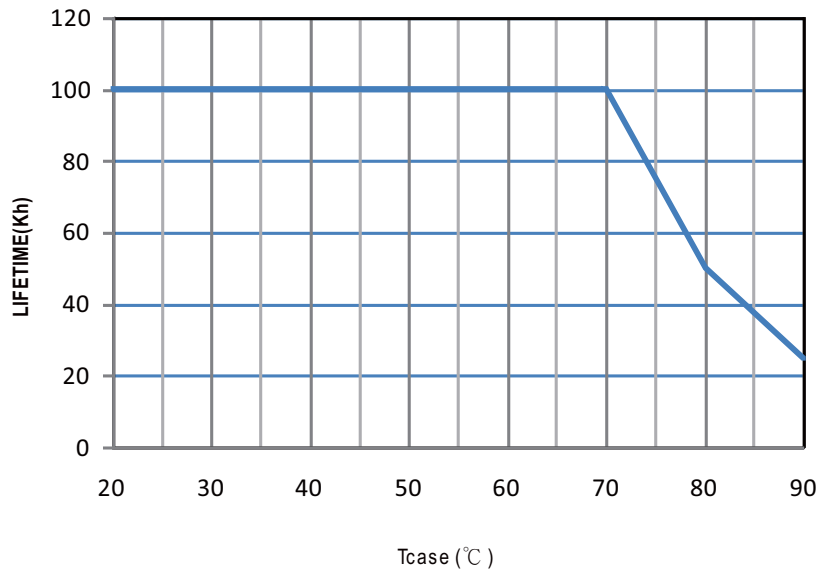

MECHANICAL SPECIFICATION

Case No. 228 Unit:mm

※A-Type

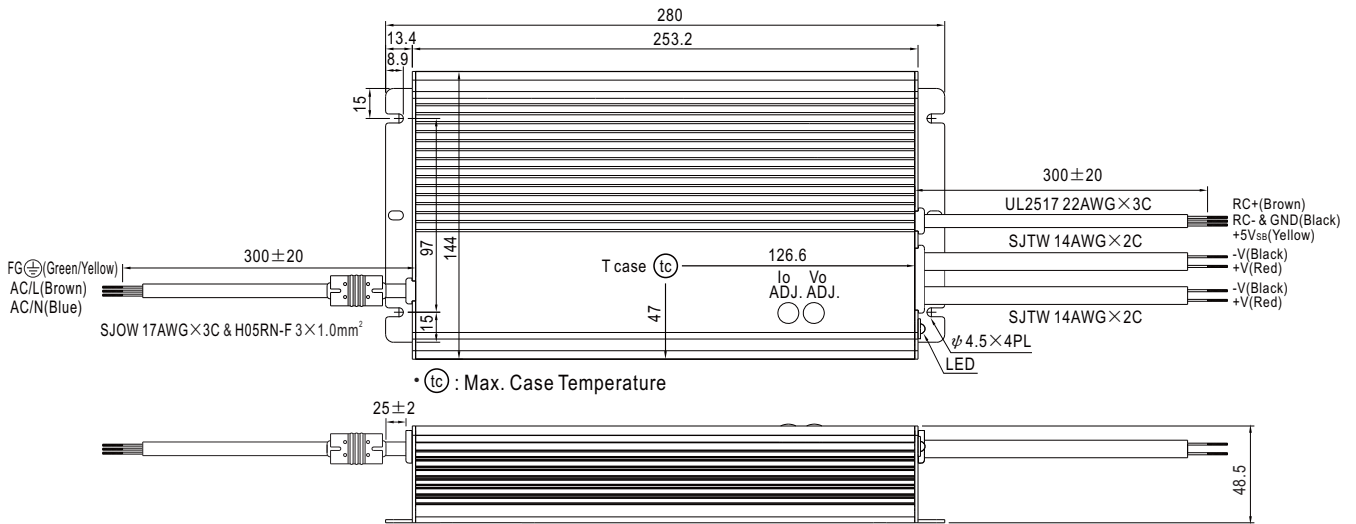

※B-Type

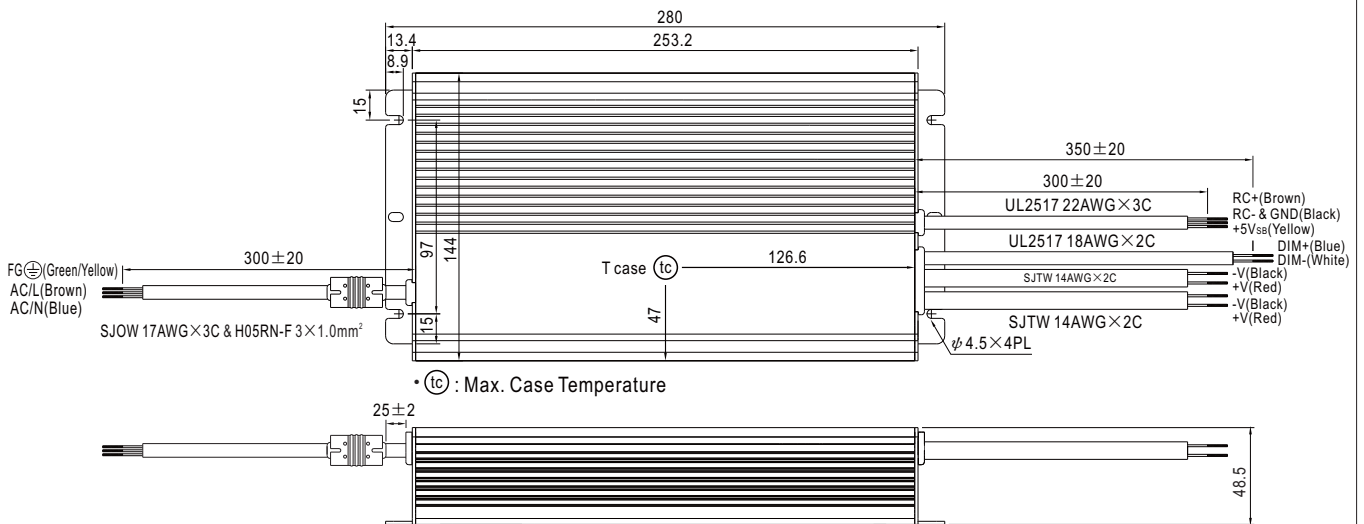

※AB-Type

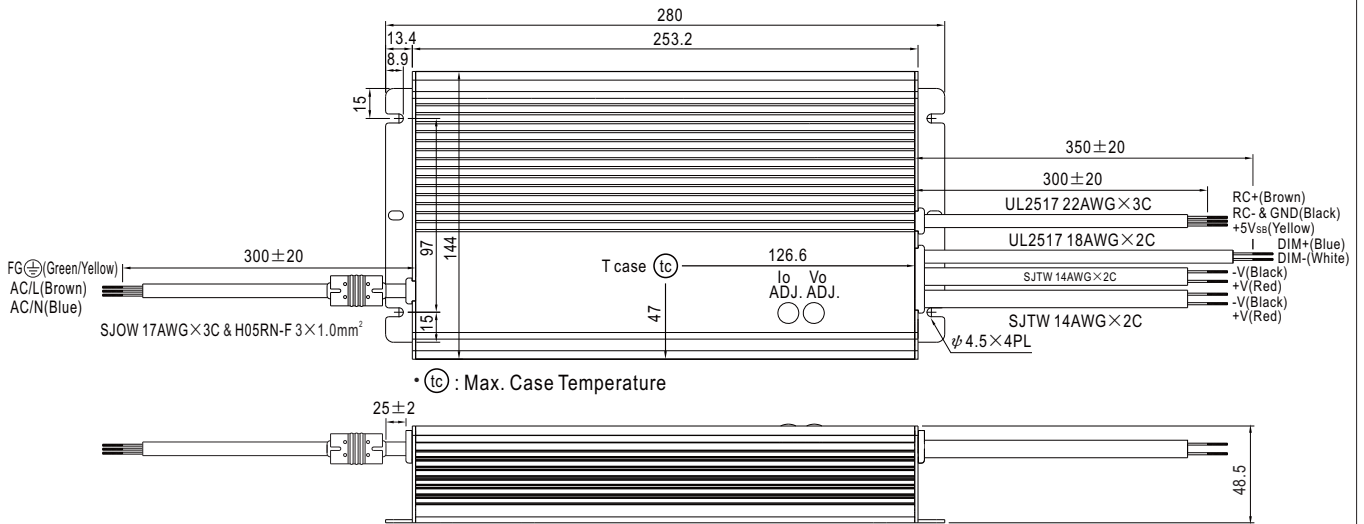

※Blank-Type

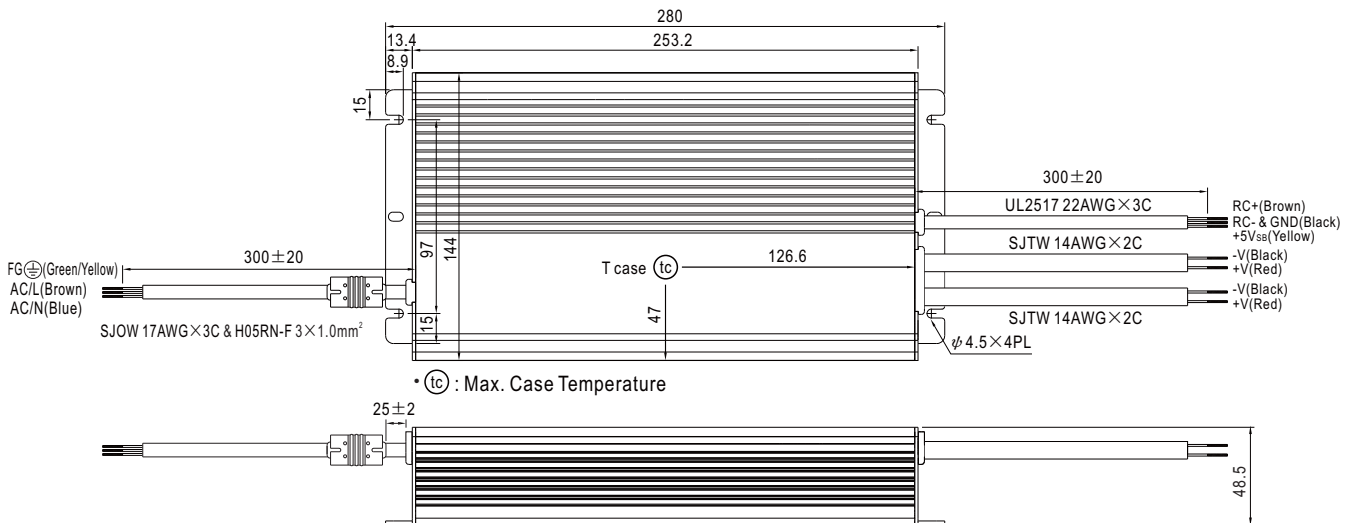

■ INSTALLATION MANUAL

Please refer to : <http://www.meanwell.com/manual.html>